

 **TRACMASTER**
The landscape machinery specialists



CAMON Lawn Scarifier

ORIGINAL INSTRUCTION MANUAL



Manufactured by Tracmaster Ltd

Before commissioning the machine, read operating instructions and observe warning and safety instructions.

Manufacturer Details

Tracmaster Ltd
Units 6-7 Winterpick Business Park
Hurstpierpoint Road
Wineham
Henfield
BN5 9BJ
UNITED KINGDOM
Tel: +44 (0)1444 247689
www.tracmaster.co.uk
info@tracmaster.co.uk

Machine Details

Model: CAMON LS52 Lawn Scarifier

Serial No:

B	0	6	-	1	1	1	1	1
---	---	---	---	---	---	---	---	---

Engine Serial No:

G	A	A	A	A	-	1	1	1	1	1	1	1
---	---	---	---	---	---	---	---	---	---	---	---	---

Purchase Date:

D	D	-	M	M	-	Y	Y	Y	Y
---	---	---	---	---	---	---	---	---	---

Supplier:

Table of Contents

1.0	Introduction	2
1.1	Welcome.....	2
1.2	About This Manual	2
2.0	What the Machine is Designed For	3
2.1	Applications	3
3.0	Specifications	4
4.0	Unpacking and Assembly	5
4.1	Major Components Diagram	5
4.2	Unpacking Instructions	5
5.0	Safety Instructions – Pre-Operation	6
5.1	Basic Safety Instructions.....	6
5.2	Main Components and Operating Elements	6
5.3	Engine and Drive.....	6
5.4	Operating Lever	6
5.5	Height Adjustment.....	6
5.6	Collection Bag.....	7
5.7	Rotor Shaft.....	7
5.8	Commissioning	8
5.9	General Safety Instructions	8
5.10	Engine Specific Safety Instructions	10
5.11	Machine Safety Sticker Explanations	10
6.0	Safety Instructions Starting and Operating	12
6.1	To Start the Engine	12
6.2	To Stop the Engine	13
6.3	Safety Equipment	13
6.4	Operation.....	13
6.5	Procedure for Unexpected Shut Down.....	15
6.6	How to Clear Unwanted Debris from the Underside of the Machine	15
6.7	Residual Risks of the LS52 Scarifier.....	15
7.0	Maintenance	16
7.1	Schedule	16
7.2	Basic Maintenance	16
7.3	Advanced Maintenance.....	16
7.3.1	Belt.....	16
7.3.2	Removing Cartridge/Rotor Assembly.....	17
7.3.3	Fitting Cartridge/Rotor Assembly.....	18
7.3.4	Blades.....	18
7.4	Engine.....	21
7.4.1	Check Engine Oil Level	21
7.4.2	Change Engine Oil	22
7.4.3	Air Filter	22
7.4.4	Spark Plug	22
7.5	Cleaning.....	23
7.6	Troubleshooting.....	23
7.6.1	Machine	23
7.6.2	Engine	23
7.6.3	Lubricants.....	23
8.0	Transportation, Storage and Handling	24
8.1	Transportation	24
8.2	Storage.....	24
8.3	Handling	24
9.0	Spare Parts	25
9.1	Parts Diagrams.....	25
10.0	Service Record	26
11.0	EC Declaration of Conformity	27
12.0	Warranty Information	28

1.0 Introduction

1.1 Welcome

Welcome to Tracmaster and thank you for choosing CAMON.

We are confident that you will be more than happy with your machine.

Your machine is covered by a comprehensive warranty. However, the lifespan of your CAMON machine depends on a number of factors. It is important that you read this manual carefully and follow the instructions regarding operation, maintenance, and care.

1.2 About This Manual

It is crucial that you read this manual carefully and understand it. Reading and understanding this manual should prevent you from operating the LS52 incorrectly and so extend the life of the machine.

This manual also contains important safety information about your machine. You must observe all safety instructions at all times. CAMON machines are often updated and improved so models may vary due to differences in specifications.

Any illustrations, descriptions, specifications, and technical data in this manual is correct at the time of printing.

For any questions relating to this manual please contact us.

During office hours (UK) we can be contacted on:

Phone: +44 (0)1444 247689

Email: info@tracmaster.co.uk

Website: www.tracmaster.co.uk



2.0 What the Machine is Designed For

2.1 Applications

The CAMON LS52 Lawn Scarifier has been designed by Tracmaster for removing the dead thatch and moss from lawns and other grassed areas.

The benefit of scarifying a lawn is that it allows air, water and nutrients to reach the roots of the grass whilst removing unwanted dead and foreign material.

The blades of the CAMON LS52 Scarifier are designed to pass through the grass ONLY - they are NOT designed to make contact with solid ground at any point during operation.

The machine will be damaged should blades continuously come into contact with solid ground.

DO NOT use the CAMON LS52 Scarifier for cutting grass or slitting the ground.

Both operations will result in damage to the machine.

Operating the machine on non-grass surfaces such as concrete or tarmac will cause damage to the LS52 Scarifier.

DO NOT scarify your lawn if there is a likelihood of high temperatures or drought.

Irrigate the lawn if necessary to ensure that the grass benefits from its treatment.

3.0 Specifications

ENGINE	
Engine Manufacturer	Honda
Engine Model	GX200
Engine Type	4-stroke OHV, single cylinder
Net Engine Power	4.1kW (5.5hp) @ 3600rpm
Engine Shaft Size	¾" straight
Spark Plug	BPR6ES (NGK) / W20EPR-U (DENSO)
Spark Plug Gap	0.70 - 0.80mm
Engine Ignition Type	Recoil
Cold Start System	Choke
Fuel Tank Capacity	3.1 litres
Fuel Type	Unleaded
Fuel Consumption	1.7 litres per hour @ 3600rpm
Air Filter	Paper and foam
Rated Engine Speed	3600rpm
Working RPM	2800rpm
Engine Oil	10w/30 API SJ or equivalent
Engine Oil Capacity	0.6 litres
Dry Weight	16.1kg

The power rating of the engine indicated in this table is the net power output tested on a production engine for the engine model and measured in accordance with SAE J1349 at a specified rpm.

MACHINE				
Model	LS52			
Working Width	52cm			
Cartridge Types	Free Swinging	Fixed	Spring Rake	Renovation
Number of Blades	39	20	39	20
Direction of Rotor	Rotor rotates in the same direction as travel			
Clutch Type	Centrifugal			
Height Adjustment	From 0mm above ground to 20mm			
Discharge	Onto ground or into bag if fitted			
Wheel Types	Solid rubber			
Steering Handle	Foldable			
Noise Level	101 dB(A)			
Vibration Acceleration Value	6.2ms ²			
Max Gradient for Operation on Slope	20 degrees			
Weight	72kg			
Dimensions (l x w x h)	120 x 69 x 98cm			

4.0 Unpacking and Assembly

4.1 Major Components Diagram



4.2 Unpacking Instructions

Open the top of cardboard box.

Cut the box open by using a sharp knife to cut down through the four corners of the box.

Swivel the folded top part of the handlebar until it locates into position extending from the lower handlebar arms and lock in position with the locating pin.

Push the four wheels onto the axles of the Scarifier and fasten in place using the penny washer, M8 spring washer, and M8 x 16 bolt provided.

Push the machine forward safely and gently off the pallet.

Dispose of the cardboard box and other padding material, please reuse or recycle where possible.

5.0 Safety Instructions – Pre-Operation

5.1 Basic Safety Instructions

Before starting the machine, read and understand these operating instructions.

5.2 Main Components and Operating Elements

Below is a description of the main components of the LS52 Lawn Scarifier and how they operate.

5.3 Engine and Drive

The Honda GX200 is a four stroke engine that runs on standard unleaded fuel.

The engine is air cooled and therefore it is important that the grille covering the recoil rope is kept clear from debris.

The engine air filter cleans the air sucked in by the engine. A clogged air filter will reduce performance.

The engine is fitted with a fuel on/off lever and a choke lever. Read the engine operating instructions to understand the operation of these levers.



5.4 Operating Lever

The LS52 Lawn Scarifier rotor shaft is engaged by using the lever located underneath the top of the handlebar.

PLEASE NOTE THAT THIS IS A TWO STAGE LEVER. THE GREY BUTTON MUST BE DEPRESSED BEFORE THE MAIN LEVER CAN BE PULLED UP.

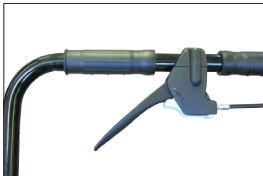

This lever increases the engine speed to a level that will engage the centrifugal clutch fitted to the engine drive shaft. Once the clutch has been engaged it will transfer the engine power to the rotor shaft that will rotate at high speeds within the chassis of the Scarifier.

5.5 Height Adjustment

The height of the blades of LS52 Scarifier is altered using the two large knobs at the front of the machine.



The top knob is connected to the centre of the front axle via a threaded rod.

Rotating the knob in each direction will raise or lower the front axle in relation to the main chassis of the machine and in turn alter the height of the blades with the chassis.

The second knob located below the top knob on the threaded rod is used to fix the position of the threaded rod and consequently the height of the blades relative to the front axle.

5.6 Collection Bag

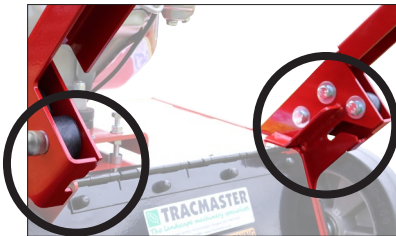

If fitted, the collection bag will collect the thatch and moss that is removed.

Use the central lifting handle when connecting or disconnecting the bag from the machine.

Always stop the engine and wait for the blades to stop rotating by removing or replacing the collection bag.

To attach the collection bag onto the machine, first lift the safety back flap on the rear of the machine chassis with one hand. Then whilst holding the bag with your other hand guide the two small metal rods protruding from either side of the collection bag frame into the two channels that have been formed to hold the bag.

5.7 Rotor Shaft

The LS42 can be fitted with a choice of cartridges.

Free Swinging Blades

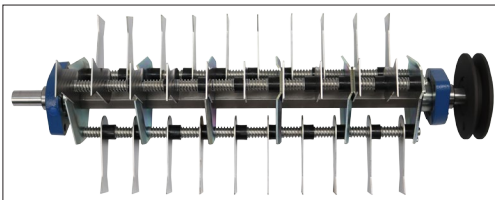

Three rods with each rod holding 13 hardened steel blades (39 in total). The blades are separated using spacers and springs. Each set of 13 blades on a rod is offset from the other two rods.

Fixed Blades

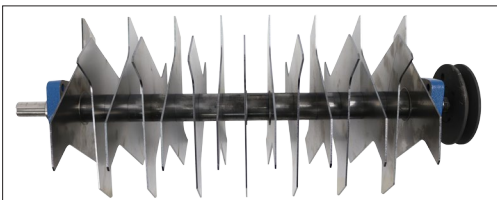

The rotor shaft holds 20 hardened steel blades. The blades are separated using spacers.

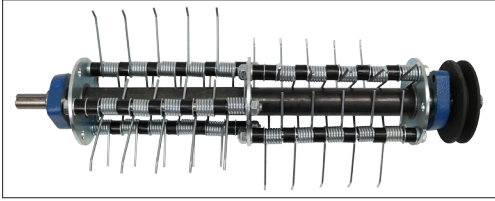
Spring Rake

Three rods with each rod holding 13 springs (39 in total). The springs are separated using spacers. Each set of springs on a rod is offset from the other rods.

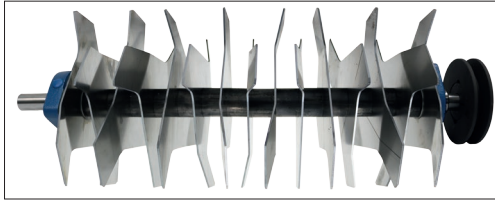
Renovation Blades

The rotor shaft holds 20 hardened steel blades. The blades are separated using spacers.

5.8 Commissioning

Prior to operation it is necessary to check the engine oil level and add engine oil level to the levels indicated in the table in section 6.1.

The engine fuel tank will not contain fuel so will need filling to the recommended level before use.

5.9 General Safety Instructions

Be aware of all the safety requirements for the machine.

Visually check the machine for operational safety, complete components and fixed guarding prior to each use.

Read and be aware of the warning and instruction signs located on the machinery.

Cordon off the work area to access from the general public.

Before starting work clear the area of any objects that may cause damage to the machine.

Do not operate the machine if you are under the influence of alcohol or drugs. This equipment must only be operated by persons who are medically fit both physically and mentally.

Only work in good light and visibility.

Wear the correct personal protection equipment as instructed by this manual.

Operator clothing should not be loose and footwear should offer good grip.

Know how to stop the machine in an emergency.

5.10 Engine Specific Safety Instructions



PETROL IS HIGHLY FLAMMABLE. ALWAYS STOP THE ENGINE AND ENSURE THE FUEL TAP IS TURNED OFF BEFORE REFUELING, OR WHEN TRANSPORTING, CLEANING, OR MAKING ADJUSTMENTS TO THE MACHINERY.

Do not smoke or use a naked flame when refueling.

Use only unleaded petrol from fuel containers designed for this purpose. Refuel outdoors only and replace the fuel tank cap securely.

Do not mix oil with the fuel.

Leave one inch of space in the fuel tank during refilling.

Clear up any petrol spillages immediately.

Always start the engine in the open air. Starting an engine within a confined space can lead to the inhalation of toxic substances.

Avoid contact with the engine during operation as it will become hot. Leave the engine to cool prior to contact and storage.

Never interfere with the control settings of the engine.

5.11 Machine Safety Sticker Explanations



**Danger – moving blades.
Keep hands and feet away.**



Warning: Rotating blade hazard.
Do not operate with guard removed.
Always remove the spark plug before servicing.



Ensure safety guards are in place. Machine MUST NOT be operated without guards.



Maximum sound power level (LWA).
Ear protection must be worn when operating the machine.



ALWAYS wear suitable Personal Protective Equipment (PPE):

- Ear Defenders
- Eye Protection
- Foot Protection
- Safety Gloves



- ① Read operating instructions before use.
- ② Remove spark plug before servicing or performing maintenance.
- ③ Warning: Keep bystanders away.

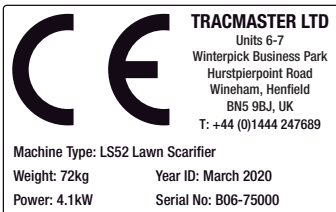

Machine identification label. Indicates compliance with European standards (CE mark). Includes unique serial number, machine weight, power output, and month and year of manufacture.

It is important that these stickers are in good condition, are legible, and are in the correct positions on the LS52 Lawn Scarifier. If any of these stickers are missing or damaged then they must be replaced. They can be obtained from Tracmaster Ltd.

6.0 Safety Instructions Starting and Operating

6.1 To Start the Engine

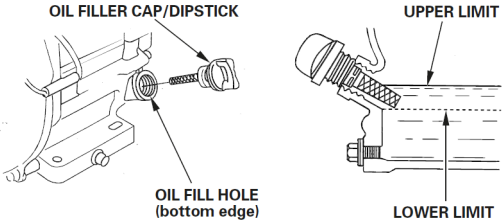
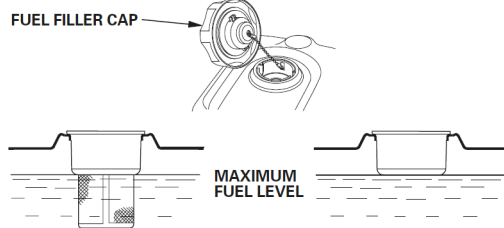
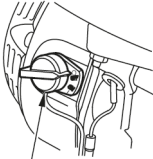
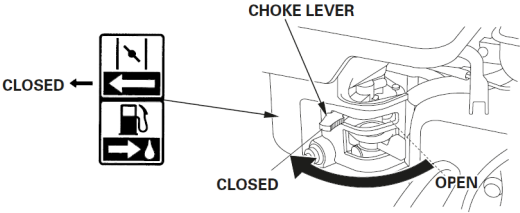
<p>Using the dipstick provided, check the engine oil level. Top up with SAE 10W/30 oil, API SJ or equivalent, if the dipstick is clear of oil.</p>	 <p>OIL FILLER CAP/DIPSTICK</p> <p>OIL FILL HOLE (bottom edge)</p> <p>UPPER LIMIT</p> <p>LOWER LIMIT</p>
<p>Check the fuel level. Refill as necessary and as determined by the fuel tank type – see diagram.</p>	 <p>FUEL FILLER CAP</p> <p>MAXIMUM FUEL LEVEL</p>
<p>Switch the engine ignition switch to the ON position.</p>	 <p>ENGINE SWITCH</p>
<p>Turn the fuel tap located on the engine carburetor to the ON position. If the engine is cold or has not been operated recently set the choke lever on the carburetor to the ON position.</p>	 <p>CHOKE LEVER</p> <p>CLOSED</p> <p>CLOSED</p> <p>OPEN</p>

Pull the engine recoil handle slowly until it engages then pull hard and fast to start the engine.

After the start, guide the cord back into its position. Do not let it snap back.

Once the engine has started, if the choke lever has been used, return this to its OFF position after the engine has run for a few seconds.

6.2 To Stop the Engine

Release the operating lever.

Switch the engine ON/OFF switch to the “O” OFF position.

Turn the fuel tap lever to the OFF position.

Ensure the blades have stopped prior to moving the machine.



WARNING: THE EXHAUST COVER MAY BE HOT – DO NOT TOUCH.

6.3 Safety Equipment

The LS52 operator must be wearing:

- Ear Defenders
- Gloves
- Protective Footwear
- Safety Glasses

6.4 Operation

Before scarifying can be carried out the grass must be cut short and be cleared of any objects such as stones or sticks that would damage the Scarifier, or be picked up and thrown by the rotating blades.



WARNING: SCARIFYING LONG GRASS WILL QUICKLY CAUSE DAMAGE TO COMPONENTS OF THE MACHINE. WE RECOMMEND THE GRASS IS CUT PRIOR TO SCARIFYING.

Do not operate the Lawn Scarifier on wet lawns or in wet weather.

Do not operate the engine in a confined space where dangerous carbon monoxide fumes can collect.

Operate the machine only in daylight or in good artificial light.

Always be sure of footing on slopes.

Walk never run.

Exercise extreme caution when changing direction on slopes.

Use extreme caution when reversing or pulling the machine towards you.

Stop the blades if the machine has to be tilted for transportation. Do not operate the blades when crossing surfaces other than grass and when transporting the machine to and from the working area.

Never operate the machine with defective guards, or without safety devices, for example deflectors and or catchers in place.

Do not change the engine governor settings or over speed the engine.

Disengage all levers, by releasing them, before starting the engine.

Start the engine carefully according to the instructions.

Do not tilt the machine when starting the engine.

Do not put hands or feet near or under the rotating parts. Keep clear of the discharge opening at all times.

Never pick up or carry the machine whilst the engine is running.

Avoid operating the machine in bad weather conditions especially if there is the risk of lightning.

Set the operating height by screwing the top adjuster knob either up or down and locking the desired height with the locking handle.



WARNING: THE BLADES MUST NOT BE ALLOWED TO TOUCH THE GROUND AT ANY POINT DURING OPERATION.

If using the collection bag, ensure that it is mounted correctly and is secure.

Lift the operating lever to engage the rotor shaft and walk at a slow steady pace pushing the machine ahead of you.

To turn the LS52 Scarifier 180°, release the operating lever, put light downwards pressure on the handlebars and rotate the machine on its rear wheels.

Do not work the Scarifier on slopes of more than 20° and always work across the slope, not up and down it.

Once the collection bag has become full, release the operating lever, turn off the engine and ensure the rotor shaft has stopped turning. Remove the collection bag and empty. Re-attach the bag securely and re-start the engine to continue scarifying.

Stop the engine and disconnect the spark plug wire before:

- a) Clearing blockages
- b) Checking, cleaning or working on the machine
- c) After striking a foreign object
- d) If the machine starts to vibrate abnormally.

Stop the engine and disconnect the spark plug wire

- a) Whenever you leave the machine
- b) Before refueling

Reduce the throttle setting during engine shut down and turn the fuel off on the engine at the conclusion of scarifying.

6.5 Procedure for Unexpected Shut Down

Release the operating lever.

Turn the engine operating switch located on the handlebars to the OFF position.

Ensure the rotor shaft and blades have stopped rotating prior to moving the machine.

6.6 How to Clear Unwanted Debris from the Underside of the Machine

Ensure that the engine has been turned off, remove the spark plug wire and the rotor shaft has stopped turning.

Turn the engine fuel tap to the off position.

Attach a lifting hoist to the top handlebar and lift the machine so that it tilts forward onto its front wheels. As the underneath of the chassis becomes exposed it is possible to see and remove any unwanted debris.



WARNING: ALWAYS TILT THE LS52 SCARIFIER FORWARDS TO AVOID OIL IN THE ENGINE FLOODING INTO AREAS WHERE IT WILL CAUSE DAMAGE.

6.7 Residual Risks of the LS52 Scarifier

The rotor shaft will continue to rotate for a couple of seconds once the operating lever has been released. Ensure that the blades have stopped rotating prior to moving or tilting the machine.

The LS52 Scarifier is designed to be pushed by the operator both during transportation and operation. It has no brake system and therefore the operator must hold firmly onto the machine on sloped areas.

7.0 Maintenance



IMPORTANT! BEFORE UNDERTAKING ANY MAINTENANCE ENSURE THAT THE ENGINE IS OFF AND THE FUEL TAP IS OFF.

7.1 Schedule

	Operation	Daily	Every Week	Every Month
Engine	Check engine oil level SAE 10W/30 API SJ or equivalent See separate engine manual	X	X	
Machine	Check condition of blades	X		
	Check condition of blade rods		X	
	Check belt condition			X
	Check operating lever and cable		X	
	Check collection bag condition		X	
	Check rotor shaft bearings			X
	Lubricate wheel bearings			X
	Tighten all nuts and bolts			X

7.2 Basic Maintenance

Check that all guards are fitted securely.

Ensure the cable connecting the operating lever to the engine is securely fastened at both ends and shows no sign of wear.

Ensure the wheels are held securely and the fixed pin that holds the wheels onto the axles is in place.

Check that the wheels rotate smoothly and without hindrance.

7.3 Advanced Maintenance

We strongly recommend that an Authorised Representative is consulted prior to any major machine maintenance projects.

7.3.1 Belt

Inspection Check:

Check every 25 hours that the drive belt is not frayed or cracked. If it appears frayed or cracked then it is time to replace the belt.

Changing the Belt:

Remove the three bolts that attach the belt guard to the chassis and remove the belt guard.

Release the tension from the belt by using the engine plate tension screws at the rear of the engine plate.

The drive belt has now become slack.

Grab the right-hand side of the belt close to the bottom pulley and pull as if you are trying to pull the belt off the bottom pulley.

With your other hand slowly and carefully rotate the pulley in an anticlockwise direction and ease the belt off the pulley.

The belt is now free from the machine.

To fit the new belt, start by locating the new belt in the groove of the centrifugal clutch.

Stretch the new belt tight by pulling it downwards to the bottom pulley.

Locate one side of the belt in position on the bottom pulley.

Slowly rotate the bottom pulley so that the belt is slowly eased into its place sitting in the groove of the bottom pulley.

Pull the belt towards you and pull the tension pulley past the belt, now release the belt and the using the tensioning bolts at the rear of the engine pate readjust the belt tension.

Re-attach the belt guard using the original cap screw bolts.

7.3.2 Removing Cartridge/Rotor Assembly

To access the underneath of the chassis you must use a lifting hoist to lift the handlebars of the machine so that it tilts forward over its front axle.

Remove both the belt guard and rotor shaft guard by undoing the fastening nuts and bolts.

Remove the belt as instructed above in section 7.3.1.

Remove the taper lock pulley from the rotor shaft by completely removing the two grub screws in the middle of the pulley, then using one of the removed grub screws insert it into the single hole between the 2 holes that the grub screws were removed from, as you tighten the grub screw it should push the pulley off the bush.

WARNING: Do not lose the woodruff key at this stage.

Remove the bolt holding the protection plate, rotate the protection plate over on the front axle to gain access to the chassis rotor shaft removal slots.

Remove the bolts of the pillow block bearings.

Once the bearing bolts have been removed the blade rotor will be able to be removed from the chassis by sliding it out of the chassis slots.

7.3.3 Fitting Cartridge/Rotor Assembly

Insert the cartridge/rotor into the chassis.

Refit the pillow block bearings with the bolts to fix the pillow block bearings to the chassis.

Locate the bottom taper lock pulley onto the end of the rotor shaft ensuring the woodruff key is fitted. Once the pulley is situated beneath the centrifugal clutch fix the taper lock pulley into position by tightening the 2 grub screws evenly in the original holes when the taper lock was removed.

Re-attach the belt and belt guard as described in 7.3.1.

7.3.4 Blades

Inspection Check:

Blades that have been worn so that they have become rounded must be changed for the LS42 Scarifier to function properly.

Changing the Blades:

Safety glasses and gloves must be worn.

Remove the rotor as described in section 7.3.2.

WARNING: Take note of the blade layout from the diagrams.

Free Swinging Cartridge

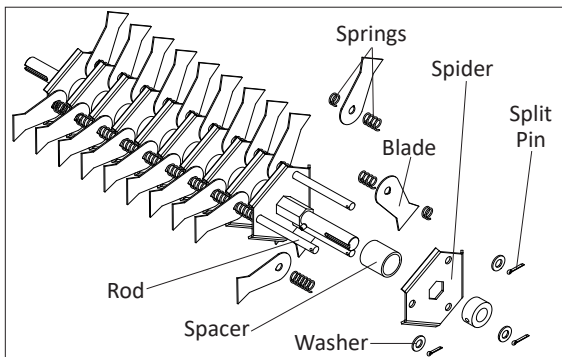

Remove one split pin from both ends of just one rod.

Slide the rod through the spiders being careful to remove the springs and blades as the rod is removed from each section.

Once the worn blades have been removed the rod should be checked for wear and if serviceable can be reinserted and the new blades located.

Reinsert the rod slowly and, in each section between spiders, pass the rod through the springs and blade in the correct order.

Continue this until each section has been filled with a blade and springs and the rod is showing through the last spider.

Renew and spread the split pins to secure the rod.

Repeat this process with the remaining two rods.

Re-attach rotor to the chassis as described in section 7.3.3.

Fixed Blade Cartridge

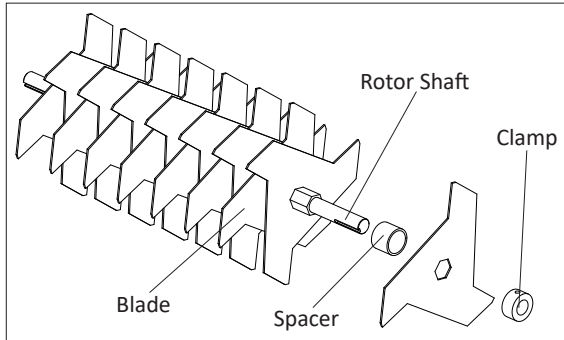

Undo the grub screw located in the clamp and then remove the clamp from the end of the rotor shaft.

Slide the blades and spacers off the rotor shaft.

Once the worn blades have been removed the rotor shaft should be checked for wear and if serviceable can be reused and the new blades located.

The hexagonal rotor shaft allows the blades to be fitted in three orientations. Each blade should be rotated by 120° so that it sits on a separate face of the rotor shaft.

After each blade has been fitted, a spacer should be added.

When fitting the blades ensure that the points of the blades are all facing the same direction (see image above).

Once all the blades and spacers are in place, fit the clamp and tighten the grub screw.

Re-attach rotor to the chassis as described in section 7.3.3.

Spring Rake Cartridge

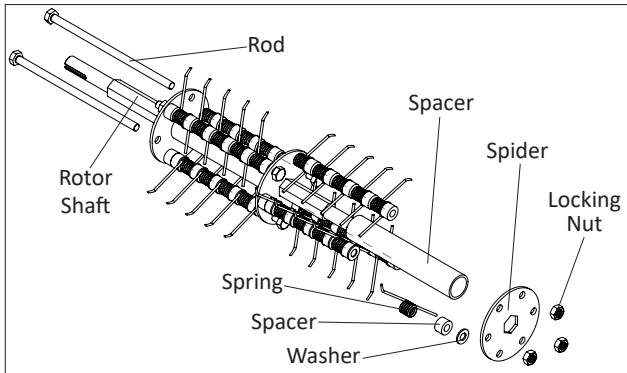

Remove the locking nut from both ends of just one rod.

Slide the rod through the spiders being careful to remove the springs, spacers, and washers as the rod is removed from each section.

Once the worn springs have been removed the rod should be checked for wear and if serviceable can be reinserted and the new springs located.

Reinsert the rod slowly and pass the rod through the springs, spacers, and washers in the correct order.

Continue this until the rod has been filled with springs, spacers, and washers and the rod is showing through the spider at either end.

Ensure that the straight end of the spring is against the rotor shaft, and that the hooked end of the spring is facing out, and they are all facing the same direction.

Renew and fasten the locking nut to secure the rod.

Repeat this process with the remaining rods.

Re-attach rotor to the chassis as described in section 7.3.3.

Renovation Cartridge

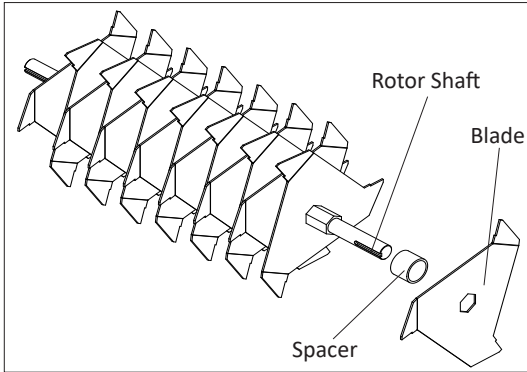

Undo the grub screw located in the clamp and then remove the clamp from the end of the rotor shaft.

Slide the blades and spacers off the rotor shaft.

Once the worn blades have been removed the rotor shaft should be checked for wear and if serviceable can be reused and the new blades located.

The hexagonal rotor shaft allows the blades to be fitted in three orientations. Each blade should be rotated by 120° so that it sits on a separate face of the rotor shaft.

After each blade has been fitted, a spacer should be added.

When fitting the blades ensure that the points of the blades are all facing the same direction (see image above).

Once all the blades and spacers are in place, fit the clamp and tighten the grubscrew.

Re-attach rotor to the chassis as described in section 7.3.3.

7.4 Engine

7.4.1 Check Engine Oil Level

This is to be checked prior to each use and every 8 hours during operation.

Check only when the engine is off and in a horizontal position.

Clean the oil filler plug and its surrounding parts.

Remove the oil filler plug. Clean the dipstick with a clean cloth and put the oil filler plug all the way back into the engine. Remove the oil filler plug and check the oil level.

Refill the oil if indicator shows more is required. For the Honda GX200 the recommended oil is SAE 10W/30 API SJ or equivalent.

7.4.2 Change Engine Oil

Refer to the engine manufacturer's manual for location of components and more detailed assistance.

Do not change the oil if the engine is hot.

The first oil change is after 50 hours of work.

Subsequent oil changes should be made after each 100 hours of work.

At extreme temperatures or conditions change the oil after every 50 hours.

Open the drain plug on the engine and the filling plug and drain the oil into a suitable container or use a suction pump to remove oil through filler neck.

Ensure the waste oil is disposed of properly.

Re-fit the drain plug and tighten.

Fill fresh engine oil through the oil filling opening. Use a funnel or similar device for ease of filling.

Replace the oil filler plug and tighten.

7.4.3 Air Filter

Inspection Check:

Remove the air cleaner cover and inspect the filter elements.

Cleaning:

See diagram below containing information provided by Honda.

Cleaning

Dual-Filter Element Types

1. Remove the wing nut from the air cleaner cover, and remove the cover.
2. Remove the wing nut from the air filter, and remove the filter.
3. Remove the foam filter from the paper filter.
4. Inspect both air filter elements, and replace them if they are damaged. Always replace the paper air filter element at the scheduled interval.

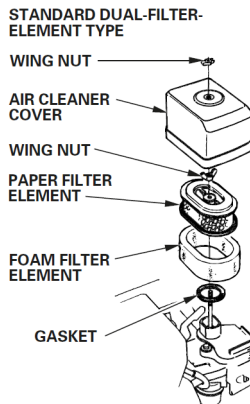

7.4.4 Spark Plug

Clean and replace.

7.5 Cleaning

After cleaning, particularly if a pressure washer has been used, ensure any lubrication points are re-lubricated.

Clean the engine with a cloth only. Avoid spraying the engine with jets of water as this may leak into the fuel and ignition systems.

7.6 Troubleshooting

7.6.1 Machine

Have all serious malfunctions on the machine and engine repaired by an authorised Tracmaster or Honda agent.

Problem	Possible Cause	Remedy
No drive to blades	Broken belt	Replace belt
Poor moss and thatch removal	Worn blades	Check condition of blades - if worn rotate or replace
	Incorrect blade height adjustment	Check height adjustment knob and readjust if too high

7.6.2 Engine

Problem	Possible Cause	Remedy
Engine does not start	Spark plug connector not connected	Connect spark plug connector
	Choke lever is not actuated	Actuate choke lever
	Fuel tank empty	Fill fuel tank
	Fuel line clogged	Clean fuel line
	Defective spark plug	Clean or replace spark plug
	Engine has too much fuel	Dry and adjust spark plug and start engine on full throttle
Engine overheats	Low engine oil	Refill immediately
	Impaired cooling	Clean cooling fan grille
	Air filter clogged	Clean air filter

7.6.3 Lubricants

Use engine oil SAE 10W/30 API SJ or equivalent, as specified by Honda.

To lubricate the roller bearings in the wheels we recommend using bio-lubricating grease.

8.0 Transportation, Storage and Handling

8.1 Transportation

Use ramps where possible to manoeuvre the LS52 Lawn Scarifier into a transportation vehicle.

The LS52 Lawn Scarifier must be fixed securely using straps and by placing chocks behind the wheels.

Always transport the LS52 Lawn Scarifier horizontally and not tilted at an angle.

Ensure that the fuel control lever on the engine is moved into the OFF position so fuel does not leak into the carburetor during transportation.

8.2 Storage

Always allow the engine to cool down prior to storage.

Always clean the machine and dry thoroughly prior to storage and ensure all lubrication points have been re-greased.

For periods of long storage, change the engine oil.

Either drain the fuel completely or fill the fuel tank and add fuel stabilizer.

Do not store the Lawn Scarifier in wet rooms, where fertiliser is stored, or in stables as heavy corrosion may occur.

Always store the machine in a horizontal position.

8.3 Handling

Do not attempt to lift the machine alone. At least two people is the minimum required.

Gloves must be worn when lifting the LS52 Lawn Scarifier.

Do not tilt the machine so that fuel can leak into the air filter of the engine.

When performing maintenance on the LS52 Lawn Scarifier when it is situated on a work bench, ensure that the machine is firmly held in position at all times.

Do not lift the machine solely by the engine at any point.

9.0 Spare Parts

9.1 Parts Diagrams

The spare parts diagrams and part numbers for the CAMON LS52 Lawn Scarifier can be found on our website or by contacting our spare parts department.

Spare parts can be ordered via the following methods:

Phone: +44(0) 1444 247689 (option 1)

Website: www.tracmaster.co.uk

Email: spares@tracmaster.co.uk

Or via your local Authorised Dealer.

10.0 Service Record

To ensure your machine is kept in peak condition we recommend that your CAMON LS52 Lawn Scarifier is serviced at regular intervals.

Contact Tracmaster on 01444 247689 to find out who your local Authorised Tracmaster Dealer is, or check our Dealer Locator online at www.tracmaster.co.uk.

Company:		Company:	
Date:		Date:	
Company Stamp: <i>(or address & authorised signature)</i>	1	Company Stamp: <i>(or address & authorised signature)</i>	2
Company:		Company:	
Date:		Date:	
Company Stamp: <i>(or address & authorised signature)</i>	3	Company Stamp: <i>(or address & authorised signature)</i>	4
Company:		Company:	
Date:		Date:	
Company Stamp: <i>(or address & authorised signature)</i>	5	Company Stamp: <i>(or address & authorised signature)</i>	6

11.0 EC Declaration of Conformity



Tracmaster Ltd declares that the machinery stipulated below complies with all the relevant provisions of:

Machinery Directive 2006/42/EC

EMC Directive 2004/108/EC

and the National Laws and Regulations adopting these directives and other relevant directive.

Manufacturer: Tracmaster Ltd
Units 6-7 Winterpick Business Park
Hurstpierpoint Road
Wineham
Henfield
BN5 9BJ
UNITED KINGDOM

Machine Description: Lawn Scarifier

Type: CAMON LS52

Harmonised Standards applied (including parts of):

EN 294:1992	Safety of machinery: Safety distance to prevent danger zones being reached by the upper limbs.
EN 954-1:1996	Safety of machinery: Safety related parts of control systems. Part 1 – general principles for design.
EN 20643:2008+A1:2012	Hand arm vibration: Laboratory measurement of vibration at the grip surface of hand guided machinery – general.
EN 12100-1:2003 & EN12100-2:2003	Safety of machinery: Basic concepts, general principles for design parts 1 & 2.
EN 13684:2004+A2:2009	Garden equipment. Pedestrian controlled lawn aerators and scarifiers.
ISO 11684:1995	Tractors, machinery for agriculture and forestry, powered lawn and garden equipment: Safety signs and hazard pictorials – general principles.

Responsible Person: Jody Symons

Position in Company: Technical Director

Address: Tracmaster Ltd, Units 6-7 Winterpick Business Park, Hurstpierpoint Road, Wineham, Henfield, BN5 9BJ

Date: March 2020

Signature: 

12.0 Warranty Information

The Warranty applies to any part of the machine, except the engine, which presents manufacturing or assembly defects in the opinion of Tracmaster Ltd.

The Warranty covers the original purchaser of the machine from the date of sale for the warranty period. The Warranty is non-transferable.

The warranty period begins the day the machine is delivered to the customer and is valid for the following periods:

- For domestic or private use: 3 years
- For commercial and hire use: 2 years

Tracmaster Ltd will replace or repair, at their discretion, free of charge, any such defective material providing the machine is returned to their workshops or an Authorised Tracmaster Dealer (contact us or see www.tracmaster.co.uk).

Should the owner of the machine wish to install the parts themselves then the labour involved will be at their cost and will not be reimbursed. Expenses arising from any subsequent failure of any part due to incorrect assembly by the owner of the machine shall be borne by the owner of the machine.

To validate warranty the Warranty Registration Card must be completed and returned, or complete the form online at www.tracmaster.co.uk/pages/warranty-registration-form.

The Warranty does not cover any transport costs, or direct or indirect losses owing to loss of use of the machine as a consequence of manufacturing defects or mechanical failure.

No Warranty shall be acknowledged in the following instances:

- The failure is caused by non-compliance of Tracmaster's directions for the correct use and operation of the machine.
- Seals and settings have been tampered with.
- Repair or modification has not authorised by Tracmaster Ltd.
- Routine maintenance, as advised in this manual, has not been undertaken.
- Incorrect fuels or lubricants have been used.
- Wear to consumable items such as blades, tines, belts, cables, tyres etc.
- Normal wear and tear.
- The failure is due to abuse / misuse / neglect.

For any issues relating to the engine please contact an authorised service centre for the engine. The engines are warranted according to the practices set by their respective manufacturers and distributors.

If an issue develops with the machine, within the warranty period, the problem must be verified by Tracmaster or an Authorised Tracmaster Dealer before any repair is undertaken.

Any other express or implied warranty is cancelled and substituted by this Warranty, whose clauses can be modified in writing only.

This Warranty provides specific legal rights and is in addition to any statutory rights. Your statutory rights are not affected by this Warranty.

For any queries relating to this Warranty Information please contact our Technical Department at Tracmaster.



CAMON LS52 Lawn Scarifier
Original Instruction Manual

© 2020 Tracmaster Ltd



Tracmaster Ltd

Units 6-7 Winterpick Business Park | Hurstpierpoint Road | Wineham | Henfield | BN5 9BJ | UK
Tel: +44 (0)1444 247689 | www.tracmaster.co.uk | info@tracmaster.co.uk